



baytex

LINER TECHNICAL INFORMATION



SIMPLICITY · PERFORMANCE · STYLE

FRAME LINER

see page 02

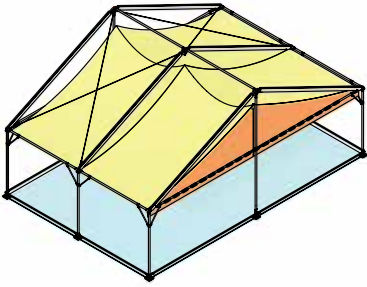

STRUCTURE LINER

see page 03

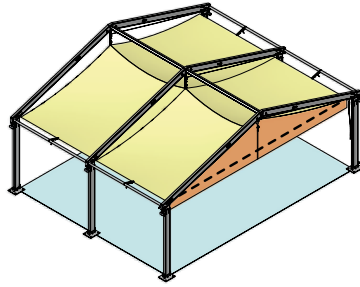

POLE TENT LINER

see page 04

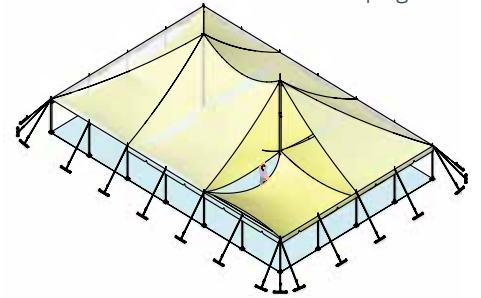

FLYING CENTRE POLE

see page 05

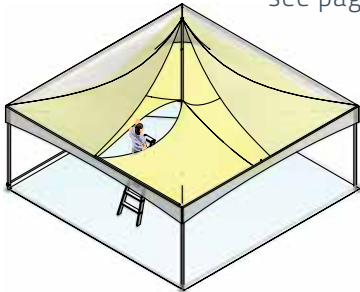

MOD LINER

see page 06

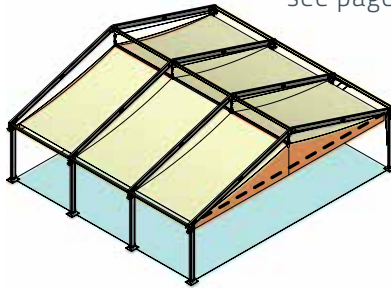

TRACK LINER

see page 07

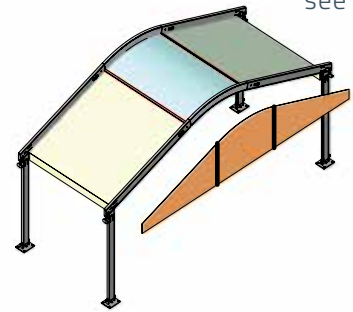

WALL LINERS & LEG DRAPES

see page 08

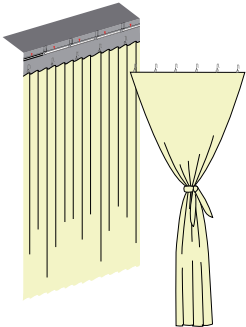

MESH LINER for CLEAR ROOFS

see page 09



WHY PURCHASE A LINER?

Baytex Liners help WOW your customers with a stunning, glamorous or fun atmosphere!

- Beautiful for weddings
- Linings add style to functions & events
- Transform commercial interiors or corporate suites

- Inherent flame retardant fabric
- Easy to install
- Excellent monetary return
- Great backup service
- Precisely designed and meticulously manufactured to fit and hang perfectly

HOOD LINER FOR CLEAR ROOFS

see page 10

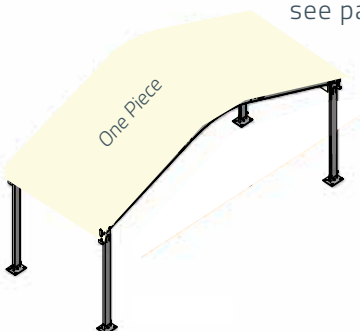

INTERNAL TRACK LINER

see page 11



For Fabric information and Lining Terminology see pages 12 | 13

FRAME LINER

FRAME BRAND NAME

2" Western Frame System / Twin Tube / Scissor Truss / other

Width x Length (see diagram below)

Width 3m-15m (10'-50')

- 3m Bays (10')
- 4.5m Bays (15')
- 6m Bays (20')

- Gable End
- Hip End
- Scissor Truss
- other

- Gable End Starters (joined to first mid section)
- Gable Ends (separate gable ends)

Do they want Wall Liners or Leg Drapes

- what is the leg height

- Gathered/Pleated - Silklite 75d (2oz)
- Flat/Smooth - Silklite 300d (6oz)

- White • Champagne • Black

Basic Installation Information

For full Installation Instructions contact Baytex

Attach halyard pulley to apex fitting using shackle

... or apex purlin using web loop

NB attach to frame before standing portal or use ladder after

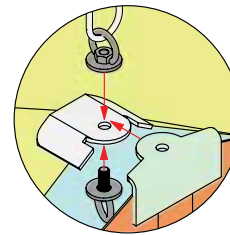
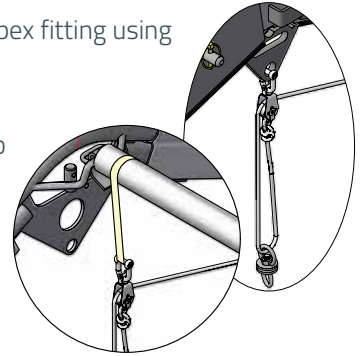

At gable & mid velcro joins connect apex patches to lifting rings

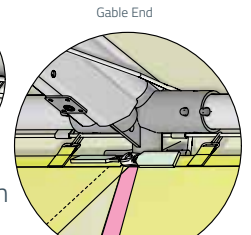
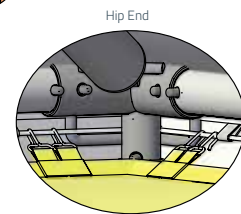

Attach liner hooks to eave cord at each leg, velcro panels together

Fasten gable corner strap to leg and thread through cambuckle, velcro panels

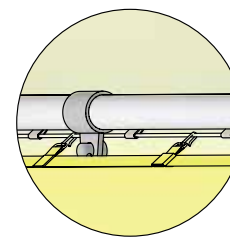
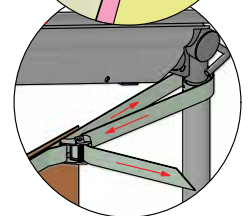

Attach remaining liner hooks to eave cord, raise liner to finished height

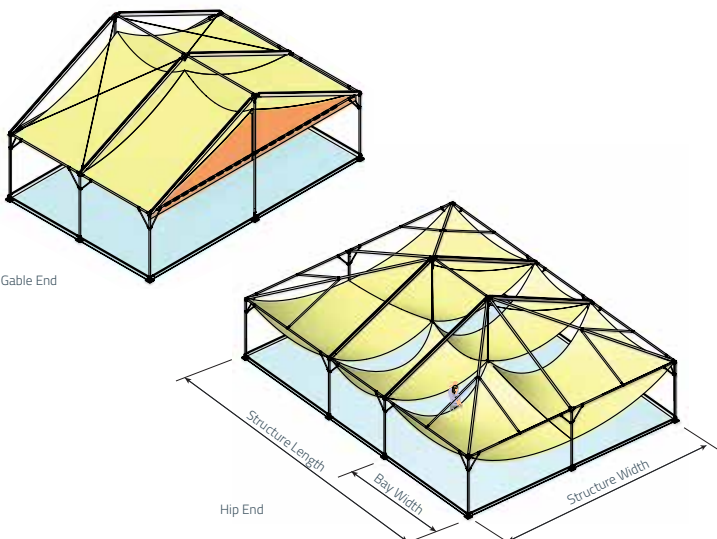

Frame Liner - Gathered / White

STRUCTURE LINER

STRUCTURE BRAND NAME

Hocker / Roder / Losberger / Anchor / Aztec / other

Width x Length (see diagram below)
eg 10mx30m (33'x60') in either

- 3m Bays (10') P1 Series
- 5m Bays (16') P2 Series

- Gable End
- Hip End
- other

- Gable End Starters (joined to first mid section)
- Gable Ends (separate gable ends)

Do they want Wall Liners or Leg Drapes

- what is the leg height

- Gathered/Pleated - Silcline 75d (2oz)
- Flat/Smooth - Silcline 300d (6oz)

- White • Champagne • Black

Basic Installation Information

For full Installation Instructions contact Baytex

Attach halyard pulley to apex fitting using shackle

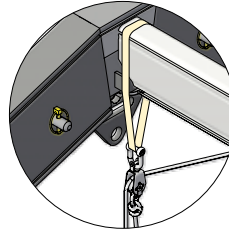

... or apex purlin using web loop

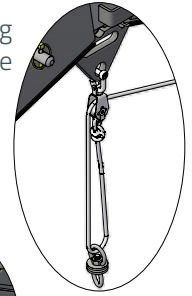
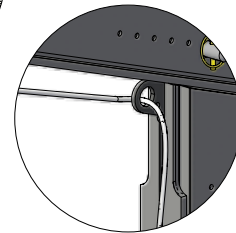

Thread pulley rope through knee fitting

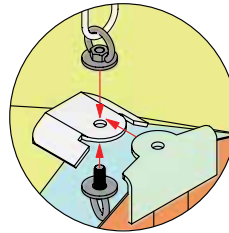

At gable & mid panel velcro joins connect apex patches to lifting ring

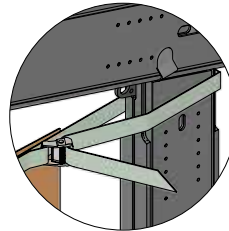

Connect sister clips, pull liner to eave and attach bungy hook to frame, velcro panels together

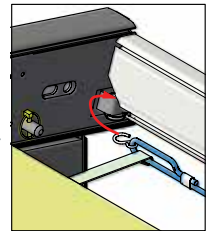

Fasten corner strap to leg and thread through cambuckle, velcro panels

P1 Series: Attach side release buckle to eave rail and tension

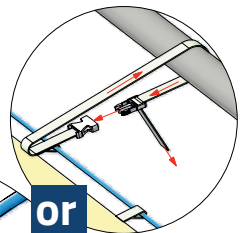

P2 Series: Attach remaining liner hooks to eaves ie around eave or into keder groove

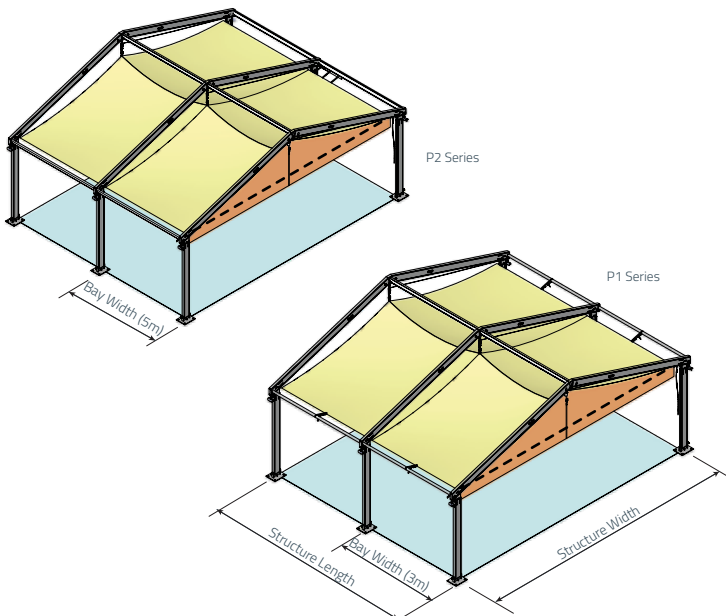
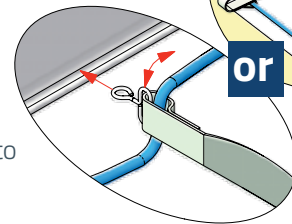

Structure Liner - P2 / Flat / White

POLE TENT LINER

POLE TENT BRAND NAME

Anchor / Aztec / Electron / Toptec Sierra / Eureka / Genesis / other

Width x Length

eg • 6m (20') • 9m (30') • 12m (40')
• 15m (50') • 18m (60') • 24m (80') • 30m (100')

Poles

- Single Row
- Multi Row

Do they want Wall Liners
or Leg Drapes

- what is the leg height

Do they want Center Pole Drapes

- what is the pole height

- Gathered/Pleated - Silklite 75d (2oz)
- Flat/Smooth - Silklite 300d (6oz)

- White • Champagne • Black

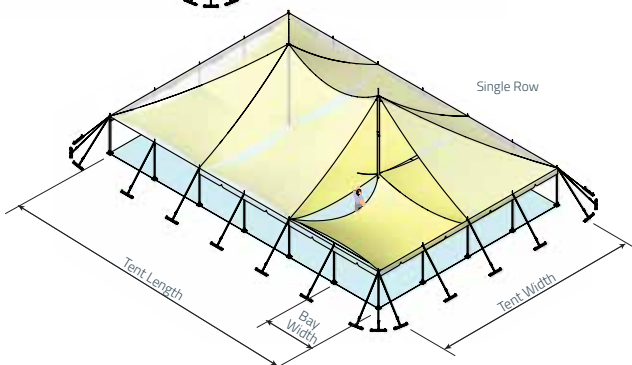
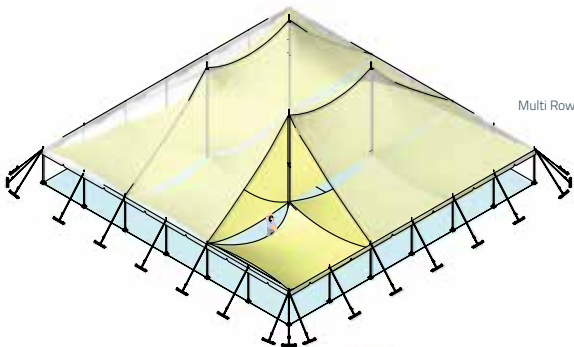

Basic Installation Information

For full Installation Instructions contact Baytex



Attach pole saddle on main tent pole top prior to installing PVC roof, lower bail ring to working height approx 1.8m (6') off ground

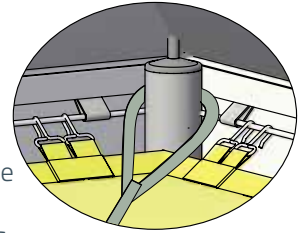

Connect corner liner hooks to eave cord on PVC roof each side of corner pole NB corners first, then panel joins and mid points, lastly pole spacings. Use web loop to pull corner to leg if required.

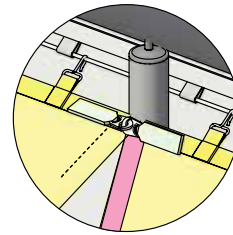

Attach liner panel to bail ring pins, connect sister clips

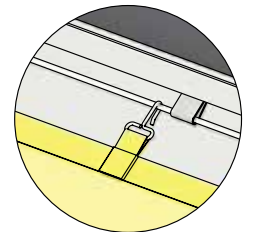

Attach all remaining liner hooks, use halyard cord to raise bail rings to finished height

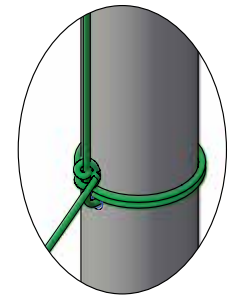

Tie off halyard cord on centre pole



Pole Tent - Gathered / White

FLYING CENTRE POLE / FETE

TENT BRAND NAME

Fete / Springtop / Flying Centre Pole / other

Width x Length

eg • 3m (10') • 4m (13') • 5m (16') • 6m (20')
or multiples of

- Single Peak
- Double Peak

Do they want Wall Liners
or Leg Drapes

- what is the leg height

- Gathered/Pleated - Silklite 75d (2oz)
- Flat/Smooth - Silklite 300d (6oz)

- White • Champagne • Black

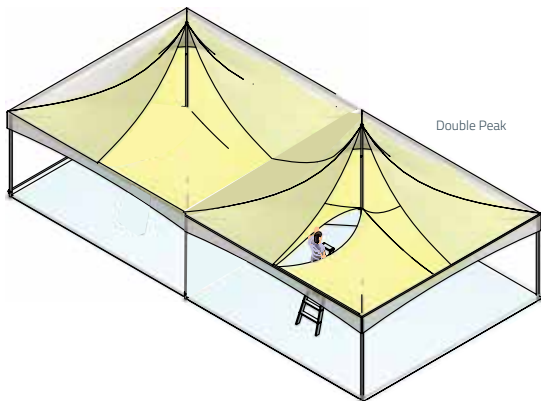

Double Peak

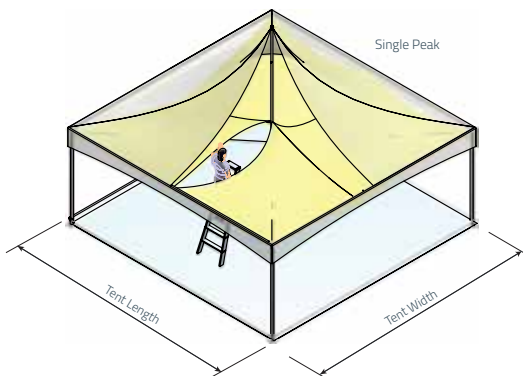

Single Peak

Basic Installation Information

For full Installation Instructions contact Baytex

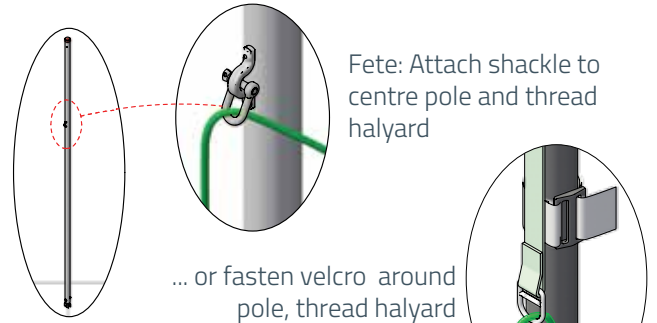

Fete: Attach shackle to centre pole and thread halyard

... or fasten velcro around pole, thread halyard through dee ring

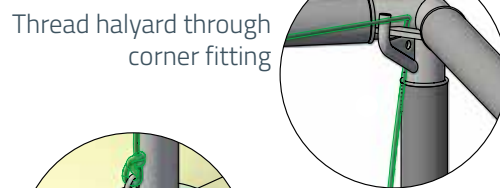

Thread halyard through corner fitting

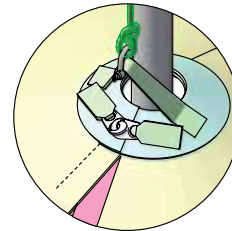

Lift liner above wires and fasten sister clips around centre pole

Connect sister clips, fasten buckles at eave

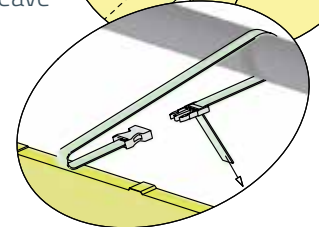
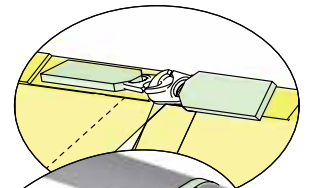

Hook webbing onto corner fitting, tension cord to base rail pin, raise liner to finished height



Flying Centre Pole Roof Liner with Leg Drapes - Gathered / White

MOD LINER

(Multi-use and extendable in width & length)

STRUCTURE BRAND NAME

Hocker / Roder / Losberger / Anchor / Aztec / other

Width x Length

- 5m Bays (16')

- Gable End
- Hip End

Do they want Wall Liners or Leg Drapes

- what is the leg height

Hardware

- Single Rail
- Twin Rail
- Triple Rail

- Gathered/Pleated - Silkline 75d (2oz)
- Flat/Smooth - Silkline 300d (6oz)

- White • Champagne • Black

Basic Installation Information

For full Installation Instructions contact Baytex

Attach halyard pulley to apex fitting using shackle

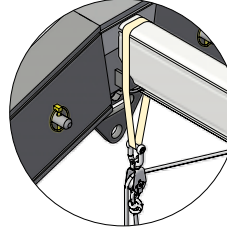

... or apex purlin using web loop

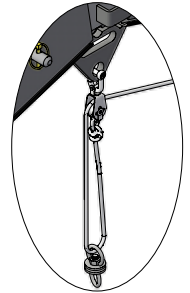

Thread pulley through knee fitting

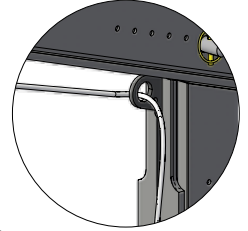

Connect sister clips, pull liner to eave and attach bungy hook to frame, velcro panels together

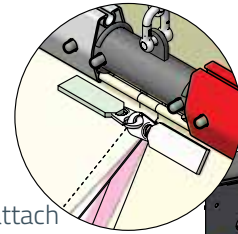

Fasten corner strap to leg and thread through cambuckle, velcro panels

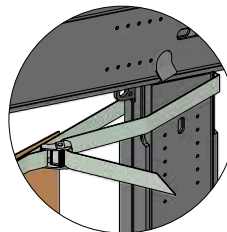

Attach remaining liner hooks to eaves ie around eave or into keder groove

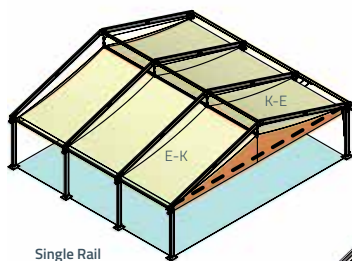
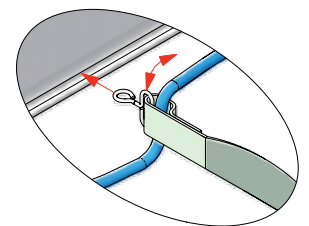

Single Rail

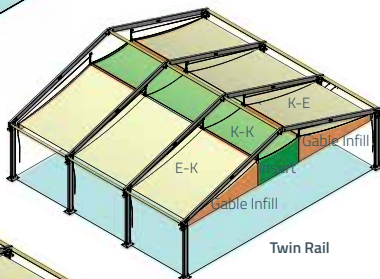

Twin Rail

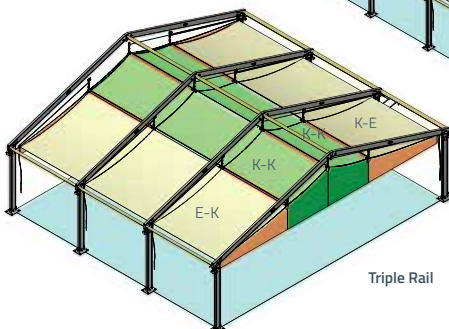

Triple Rail



Mod Liner / Flat / White

TRACK LINER (using 4 Track Rafter)

STRUCTURE BRAND NAME

Hocker / Roder / Losberger / Anchor / Aztec / other

Width x Length

- 3m Bays (10') with 4-track only
- 5m Bays (16')

- Gable End
- other

- A-Frame
- Curved Top (Arcum)
- Arched Top

Do they want Wall Liners or Leg Drapes

- what is the leg height

- Flat/Smooth - Silcline 300d (6oz)

- White • Champagne • Black

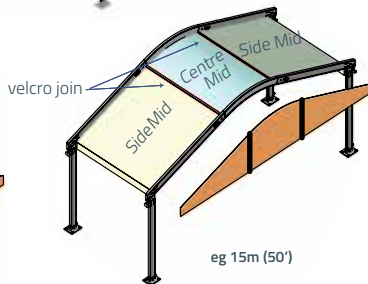
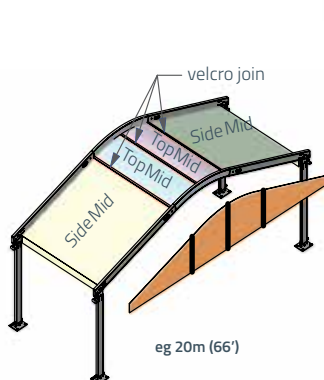
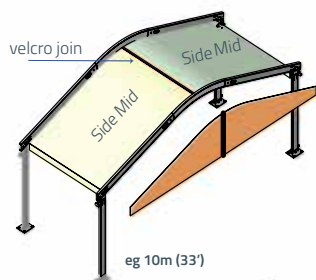
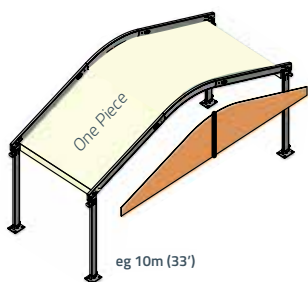
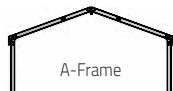

Basic Installation Information

For full Installation Instructions contact Baytex

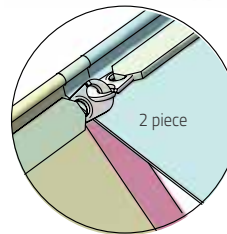
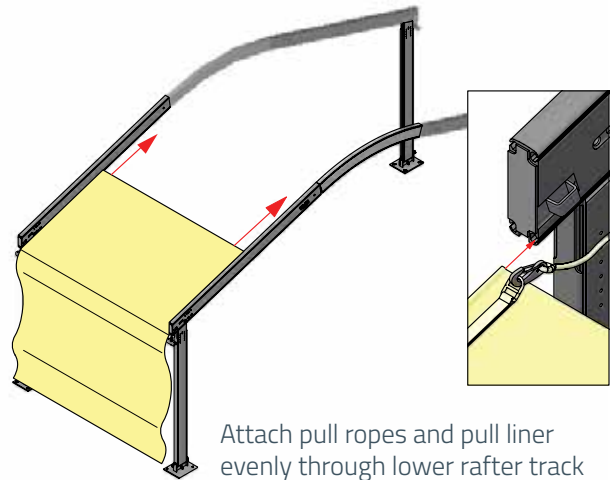

Connect sister clips, join velcro from side mid to top mid

Gables tensioned at eave level with camlock buckle and web strap

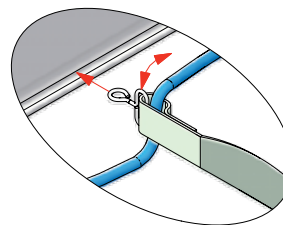
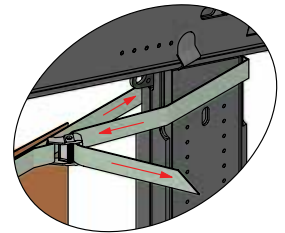

Attach remaining liner hooks to eaves ie around eave or into keder groove

Attach hooks at end of bungy

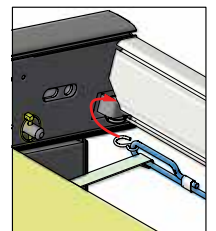

Arched Track Liner / White

WALL LINERS & LEG DRAPES

BRAND NAME

Frame, Structure, Pole, Flying Centre Pole, MOD, Track

WALL LINERS

Leg Height
ie 2.1m (7'), 2.4m (8'),
3m (10') etc

- Velcro joins
- Pocket

- Gathered/Pleated - Silklite 75d (2oz)
- Flat/Smooth - Silklite 300d (6oz)

- White • Champagne • Black

LEG DRAPES

Leg Height
ie 2.1m (7'), 2.4m (8'),
3m (10') etc

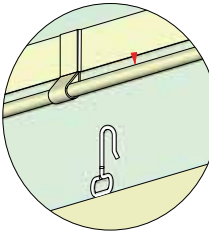

Wall Liners: attach wall liner hooks to interior roof rope

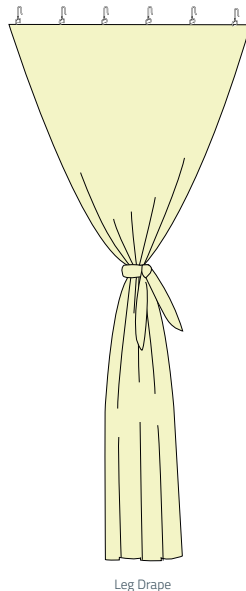
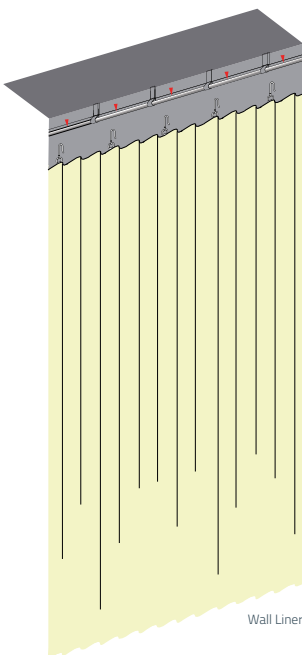

Wall Liners - Gathered / White



Leg Drapes - Gathered / White

Basic Installation Information

For full Installation Instructions contact Baytex

INTERNAL MESH LINER FOR CLEAR ROOFS

(using 4 Track Rafter)

STRUCTURE BRAND NAME

Hocker / Roder / Losberger / Anchor / Aztec / other

Width x Length

- 3m Bays (10') with 4-track only
- 5m Bays (16')

- A-Frame
- Curved Top (Arcum)
- Arched Top



A-Frame



Curved Top



Arched Top

- Serge Ferrari Soltis Mesh

- Black

Basic Installation Information

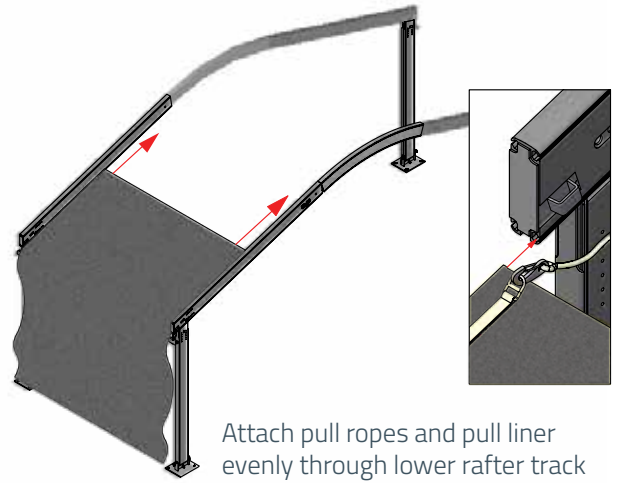

Attach pull ropes and pull liner evenly through lower rafter track

Attach hooks at end of bungy

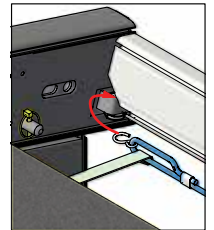

Mesh Liner to 'Beat the Heat'

OUTER HOOD LINER FOR CLEAR ROOFS

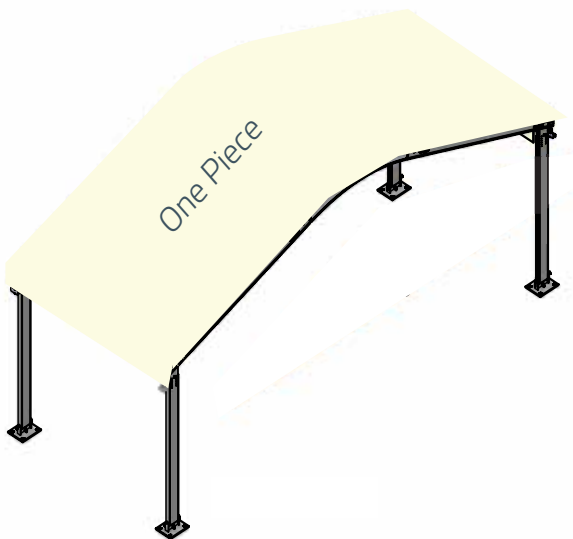
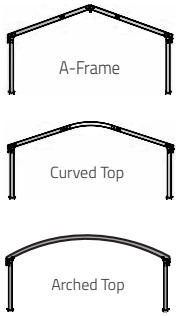
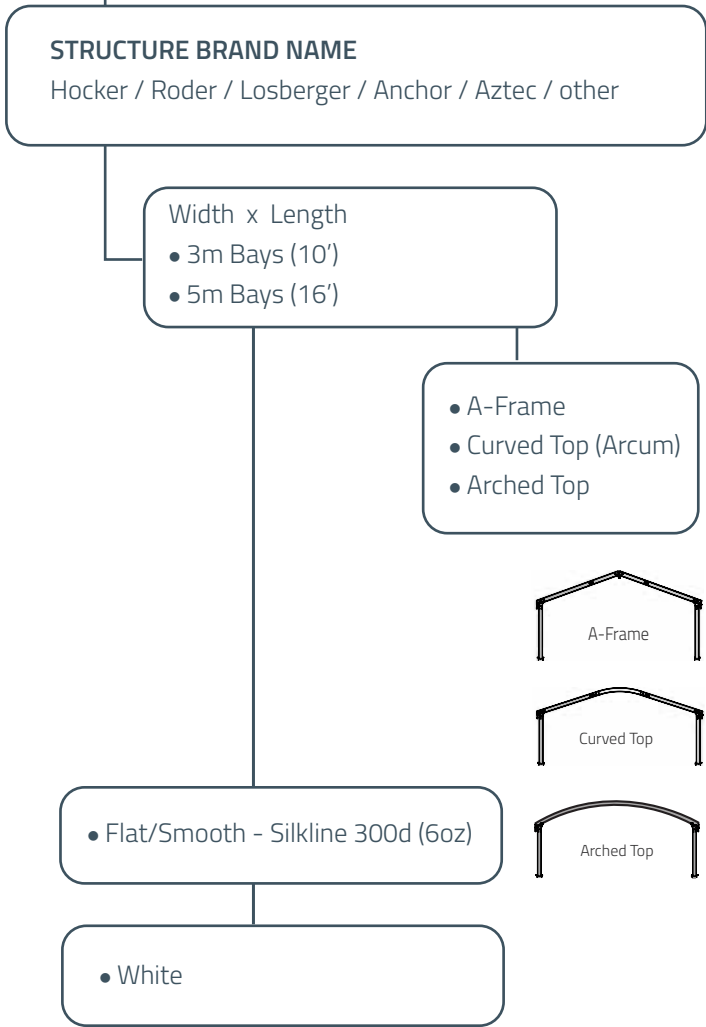

Installation Information

This will help 'beat the heat' during set up.

Simply throw over the roof and tie with ropes down the leg. This will help 'beat the heat' during set up. Each bay velcros together to make multiple bays (typically the gable end isn't covered).



Throw over Hood Liner to 'Beat the Heat'

INTERNAL TRACK LINER (using 4 Track Rafter)

STRUCTURE BRAND NAME

Hocker / Roder / Losberger / Anchor / Aztec / other

Width x Length

- 3m Bays (10') with 4-track only
- 5m Bays (16')

- A-Frame
- Curved Top (Arcum)
- Arched Top

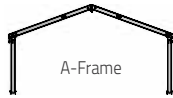

- Gathered/Pleated - Silklite 75d (2oz)

- White • Champagne • Black

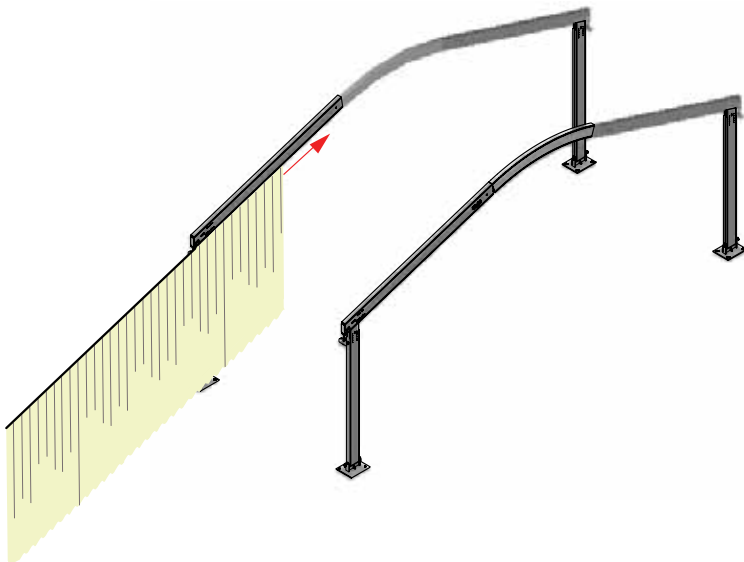

Basic Installation Information

Divides into sections for a prep area, pre-gathering, backdrop etc
Made with two side openings with thin ties.

Attach pull rope and pull liner evenly through lower rafter track.



Internal Divider Liner

FABRIC INFORMATION

Baytex Silkline Liners are manufactured from 100% polyester fibre for maximum durability and easy care. All Baytex Silkline fabrics are inherently flame retardant, they have a soft finish with a beautiful silky sheen that resists hard creasing.

FABRIC CARE INSTRUCTIONS

Silkline is an inherently flame retardant 100% polyester fabric.

It can be washed any number of times with no deterioration of the fabric's flame retardant performance. Silkline has no chemical treatment to wash out.

Follow these simple instructions for a long lasting performance:

- Treat Silkline as a delicate fabric
- Launder in a domestic or commercial washing machine
- **Only** use cool water and a mild laundry detergent
- Fluff dry thoroughly using cool or warm air only (max 50°C/120°F)
- Restuff into storage bags when completely dry
- Never store liners damp
- Spot clean bad marks only as necessary
- Use a fabric steamer or warm iron for smooth wrinkle appearance

Important:

Always avoid excessive heat as this may damage or shrink the fabric.

Fabric Type:

- FR300 (6oz) - For Flat Linings
- FR75 (2oz) - For Gathered Linings

Colour Options



Fabric Qualities



FLAME RETARDANCY CERTIFICATION

All Silkline Plus fabrics are inherently flame retardant and comply with the following International Flame Retardancy Standards:

- Europe: Classification: M1 Durability of Classification: (NF P 92-512 : 1986)
- UK: BS 5867 Pt2 Type B
- Germany: DIN 4102-1 and NTA 8007:2007 'Brandgedrag von verseiringsmaterialien' classification 'B'
- USA: NFPA 701 small scale / USA CalifoWW7101
- Australia & NZ: AS1530: Pts 2 & 3

Full reports and certifications are available to Baytex customers upon request.

BAG LINERS

Baytex Liners are supplied in labelled, colour coded Carry Bags for the complete package



LINING TERMINOLOGY

- A1 Gable End Starter
- A2 Gable Infill - on piece
- B Mid
- C Detachable Valance Swag (optional extra)
- D Wall
- E Leg Drape

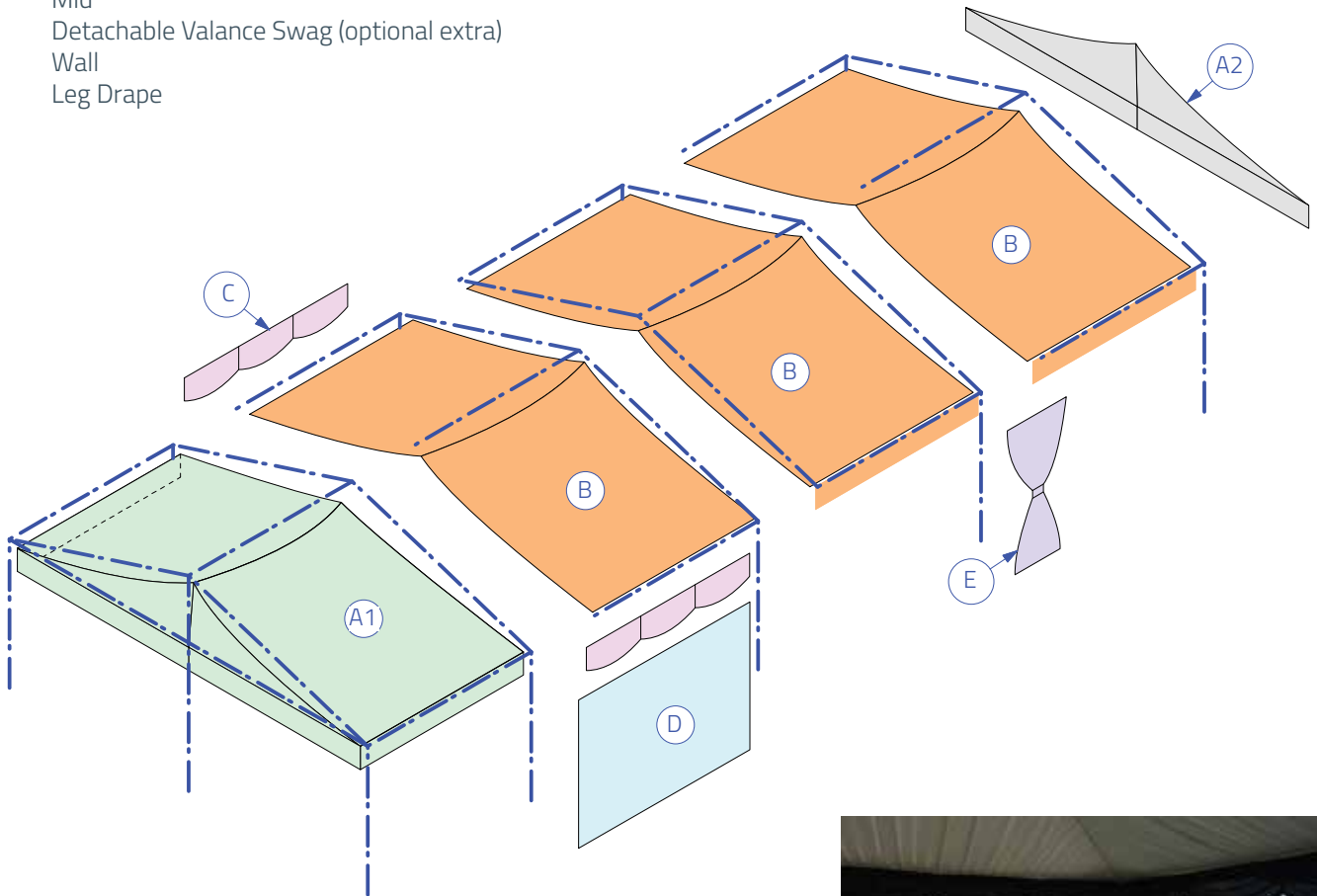

(C) Detachable Valance Swag (optional extra)

USEFUL FRAME DIMENSIONS

Often we will ask you for dimensions to confirm lining size, or in the case of a custom liner.

If you also require wall liners please supply the leg height.

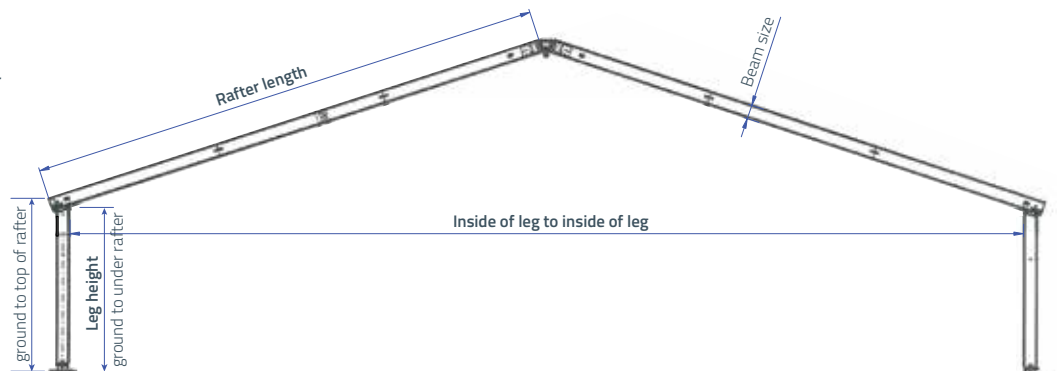



SIMPLICITY · PERFORMANCE · STYLE

New Zealand

52 Newton Street,
PO Box 4370, Mount Maunganui
New Zealand

tel +64 7 579 0190
fax +64 7 579 0194
www.baytex.co.nz

Australia

tel 02 4340 4144
mob 0400 312 314

